

Catálogo de Torneado

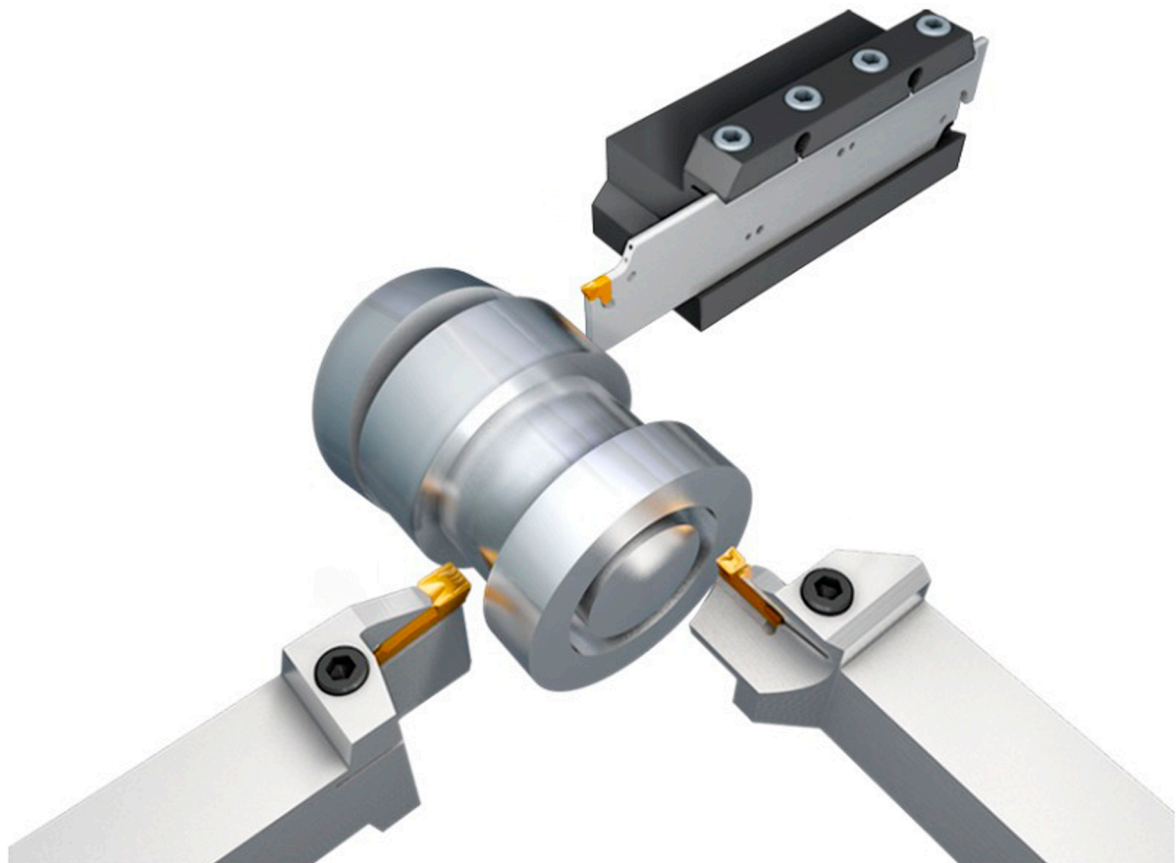

Ranurado/Tronzado



Sin precios

TN-T   LS

Placas de Torneado.....	2
Portaherramientas de Torneado.....	13
Portas y Placas de Ranurado/Tronzado.....	34
Sets de Torneado.....	38
Portaherramientas Soldadas.....	40
Cuchillas de Cobalto.....	45
Torretas, Platos y Garras.....	48

Placas de Torneado



Placas de Fresar ADMT-R 1503 de radio Cónico

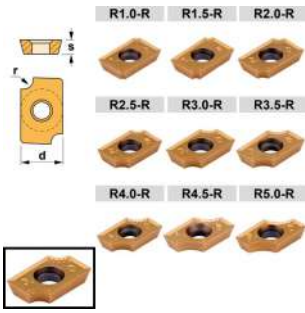

Referencia:
Fabricante: CANELA

Korloy CCGT1204..-AK H01 Placa de Torno en Aluminio Positiva



Referencia:
Fabricante: KORLOY

Canela ADMW-C Placas de radios Convexos

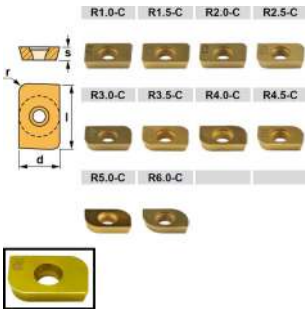

Referencia:
Fabricante: CANELA

Canela CCGT...-AL-KM15 Placa de Torno en Aluminio Positiva



Referencia:
Fabricante: KORLOY

Korloy CCGT0602..-AK H01 Placa de Torno en Aluminio Positiva



Referencia:
Fabricante: KORLOY

Taegutec CCMT060204 MT TT5100 Placa de Torno



Referencia:
Fabricante: TT

Korloy CCGT09T3..-AK H01 Placa de Torno en Aluminio Positiva



Referencia:
Fabricante: KORLOY

Taegutec CCMT09T3.. MT Placa de Torno Positiva



Referencia: PTT01
Fabricante: TT

CCMT... VP15TF Placa de Torno Positiva

* Corte Inestable
Unstable Cutting



Referencia:

Fabricante: TN-TOOLS

CNMG120404-MA MC7025 Placa de Torno Negativa



Referencia:

Fabricante: TN-TOOLS

Canela CCMT.. Placa de Torneado Positiva



Referencia: PTT05

Fabricante: CANELA

Taegutec CNMG120408 MT Placa de Torno



- Primera opción
First Option
- Segunda Opción
Second Option



Referencia:

Fabricante: TT

CNGA1204.. Placa de Torno Negativa Cerámica

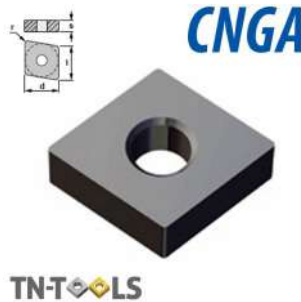

CNGA

Referencia:

Fabricante: TN-TOOLS

Taegutec CNMG1204.. PC TT9225 Placa de Torno



- Primera opción
First Option
- Segunda Opción
Second Option



Referencia: PTT04

Fabricante: TT

Canela CNGA1204... Plaquetas Torno de cerámica

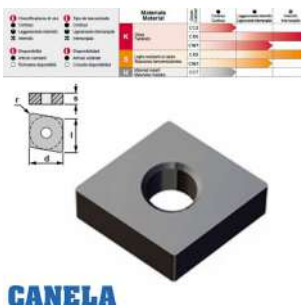

Referencia:

Fabricante: CANELA

CNMG120408-MA UE6020 Placa de Torneado Negativa



* Corte Inestable
Unstable Cutting



Referencia:

Fabricante: TN-TOOLS

YG1 CNMG... - UG Placa de Torno



Referencia:

Fabricante: YG1

YG

DCMT11T304-MV VP15TF Placa de Torneado Positiva

✳ Corte Inestable
Unstable Cutting



Referencia:

Fabricante: TN-TOOLS



KNUX160405R-M1 US735 Placa de Torno Negativa

✳ Corte Inestable
Unstable Cutting



Referencia:

Fabricante: TN-TOOLS



GY2M0300F030N-GM VP20RT Placa de Ranurado

✳ Corte Inestable
Unstable Cutting



Referencia: PRNM01

Fabricante: TN-TOOLS



TaeguTec KNUX160405 R11 TT8020 Placa de Torno Negativa

- Primera opción
First Option
- Segunda Opción
Second Option



Referencia:

Fabricante: TT



Canela HPKW Fresado de Radios Cóncavos

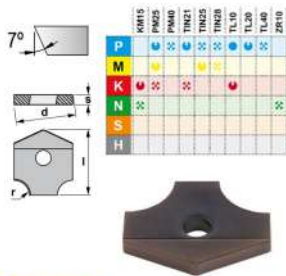

Referencia:

Fabricante: CANELA

CANELA

TaeguTec KNUX160405 L11 TT8125 Placa de Torno Negativa



Referencia:

Fabricante: TT

KNUX160405L-M1 UE6020 Placa de Torno Negativa

✳ Corte Inestable
Unstable Cutting



Referencia:

Fabricante: TN-TOOLS



Canela RCMT.. Placa de Torneado Positiva



Referencia:

Fabricante: CANELA

RCMT....

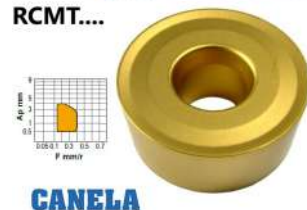

CANELA

Canela SCMT-39 Placa de Torno Positiva



Referencia:
Fabricante: CANELA

CANELA

SNMG120408-MP MC6025 Placa de Torno Negativa

☼ Corte Inestable
Unstable Cutting



Referencia:
Fabricante: TN-TOOLS



Canela SCGT-AL Placa de Torno en Aluminio Positiva



Referencia:
Fabricante: CANELA

CANELA

SNMG120408-MM MC7025 Placa de Torno Negativa

● Corte General
General Cutting



Referencia:
Fabricante: TN-TOOLS



Tungaloy SCMT1204..-PM Placa de Torno Positiva



Referencia:
Fabricante: TN-TOOLS

Tungaloy

Canela SPUN ... Placa de Torneado



Referencia:
Fabricante: CANELA

CANELA

Canela SCMW Placa de Torno Positiva



Referencia:
Fabricante: CANELA

CANELA

SPMN120308 VP15TF Placa de Torno Positiva

☼ Corte Inestable
Unstable Cutting



Referencia:
Fabricante: TN-TOOLS



Canela SPMR ... Placa de Torneado

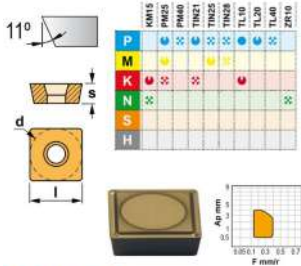

Referencia:
Fabricante: CANELA

CANELA

Korloy TCGT16T3..-AK H01 Placa de Torno en Aluminio Positiva

● Corte General
General Cutting

Referencia:
Fabricante: KORLOY



Taegutec SNMG120408 MT TT9225 Placa de Torno

● Primera opción
First Option
○ Segunda Opción
Second Option

Referencia:
Fabricante: TT



Oke TCMT16T304-OTM OP1215 Placa de Torneado Positiva para Inoxidable e Inconel

Referencia:
Fabricante: TN-TOOLS



SNMG1204..-MA VP15TF Placa de Torno Negativa

✳ Corte Inestable
Unstable Cutting

Referencia:
Fabricante: TN-TOOLS



Canela TCMT.. Placa de Torneado Positiva

Referencia:
Fabricante: CANELA



Korloy TCGT1102..-AK H01 Placa de Torno en Aluminio Positiva

● Corte General
General Cutting

Referencia:
Fabricante: KORLOY



Taegutec TCMT1.. MT TT5100 Placa de Torno

● Primera opción
First Option
○ Segunda Opción
Second Option

Referencia:
Fabricante: TT



Taegutec TNGA1604.. Placa de Torno

- Primera opción
First Option
- Segunda Opción
Second Option



Referencia:

Fabricante: TT



TNGG220404 NX2525 Placa de Torno Negativa Cermet

- Corte Estable
Stable Cutting



Referencia:

Fabricante: TN-TOOLS



TNGA1604.. Placa de Torno Negativa Cerámica



TNGA

Referencia:

Fabricante: TN-TOOLS

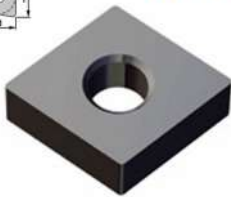

TN-TOOLS

TNMG1604..R-ES US7020 Placa de Torno Negativa

- Corte Estable
Stable Cutting



Referencia:

Fabricante: TN-TOOLS



Tungaloy TNGG1604..R-C NS9530 Placa de Torno Negativa

Referencia:

Fabricante: TN-TOOLS



TNMG1604..R-ES US735 Placa de Torno Negativa

- ✳ Corte Inestable
Unstable Cutting



Referencia:

Fabricante: TN-TOOLS



Tungaloy TNGG1604..L-C NS9530 Placa de Torno Negativa

- Corte Estable
Stable Cutting
- Corte General
General Cutting



Referencia:

Fabricante: TN-TOOLS



TNMG160404L-2G NX2525 Placa de Torno Cermet Negativa

- Corte Estable
Stable Cutting



Referencia:

Fabricante: TN-TOOLS



TNMG160404R-2G NX2525 Placa de Torno Cermet Negativa

● Corte Estable
Stable Cutting



Referencia:

Fabricante: TN-TOOLS



TNMG1604..-MA VP15TF Placa de Torno Negativa

✳ Corte Inestable
Unstable Cutting



Referencia:

Fabricante: TN-TOOLS



TNMG1604..-MP MC6025 Placa de Torno Negativa

✳ Corte Inestable
Unstable Cutting



Referencia:

Fabricante: TN-TOOLS



TNMG1604..-MA UE6020 Placa de Torno Negativa

✳ Corte Inestable
Unstable Cutting



Referencia:

Fabricante: TN-TOOLS



TNMG160408-MM MC7025 Placa de Torno Negativa

● Corte General
General Cutting



Referencia:

Fabricante: TN-TOOLS



Tungaloy TNMG160408-SM AH630 Placa de Torno Negativa



Referencia: TNMG160408-SM

Fabricante: TUNGALOY



TNMG160408-MP MC6035 Placa de Torno Negativa

Referencia:

Fabricante: TN-TOOLS



TNMG1604..L-ES US7020 Placa de Torno Negativa

● Corte Estable
Stable Cutting



Referencia:

Fabricante: TN-TOOLS



TNMG220408..-ES US735 Placa de Torno Negativa

* Corte Inestable
Unstable Cutting



Referencia:

Fabricante: TN-TOOLS

Canela TPUN.... Placa de Torno- Fresar

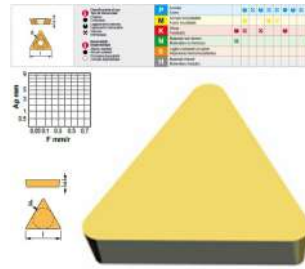

Referencia:

Fabricante: CANELA

CANELA

TPMN160308 UP20M Placa de Torno Recubierta (equivalente TPUN)

* Corte Inestable
Unstable Cutting



Referencia: TPMN160308

Fabricante: TN-TOOLS

Canela TPUX.... Placa de Torno- Fresar

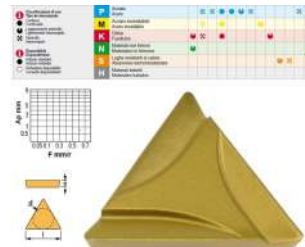

Referencia:

Fabricante: CANELA

CANELA

TPMR1603.. UE6020 Placa de Torno Positiva

* Corte Inestable
Unstable Cutting



Referencia:

Fabricante: TN-TOOLS

YG1 TPUN160308 YG602 Placa de Fresar

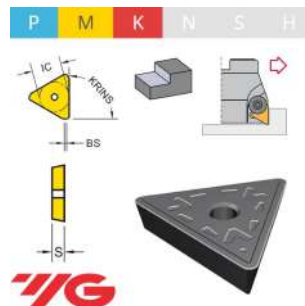

Referencia:

Fabricante: TN-TOOLS

YG

TaeguTec TPMR1603.. TT8020 Placa de Torno

● Primera opción
First Option
○ Segunda Opción
Second Option



Referencia: TPMR160308

Fabricante: TT

Korloy VCGT1604..-AK H01 Placa de Torno en Aluminio Positiva

● Corte General
General Cutting



Referencia:

Fabricante: KORLOY

VCMT160404-MP MC6025 Placa de Torno Positiva

* Corte Inestable
Unstable Cutting



Referencia:

Fabricante: TN-TOOLS

Taegutec VCMT160408 PC TT8125 Placa de Torno

- Primera opción
First Option
- Segunda Opción
Second Option



Referencia:
Fabricante: TT

WNMG080408-MP MC6025 Placa de Torno Negativa

- ✳ Corte Inestable
Unstable Cutting



Referencia:
Fabricante: TN-TOOLS

WNMG0804..-MA UE6020 Placa de Torno Negativa

- ✳ Corte Inestable
Unstable Cutting



Referencia:
Fabricante: TN-TOOLS

OKE WNMG080408-OPR OC2125 Placa de Torno Negativa



Referencia: PTOK01
Fabricante: TN-TOOLS



WNMG0804..-MA VP15TF Placa de Torno Negativa

- ✳ Corte Inestable
Unstable Cutting



Referencia:
Fabricante: TN-TOOLS

Tungaloy WNMG080408-SM Placa de Torno Negativa



Referencia: PTTY03
Fabricante: TUNGALOY



WNMG080408-MM MC7025 Placa de Torno Negativa

- Corte General
General Cutting



Referencia:
Fabricante: TN-TOOLS

Tungaloy WNMG080408-TM T9125 Placa de Torno Negativa



Referencia: PTTY04
Fabricante: TUNGALOY



También disponemos de las siguientes marcas:



Entre muchas otras...

Portaherramientas de Torneado



**Porta Herramientas de Torno CKJN 93°
Exterior Aplicaciones Cilindrado**



**Porta Herramientas de Torno CSKP 75°
Exterior Aplicaciones Refrentado**



**Porta Herramientas de Torno CKNN 63°
Exterior Aplicaciones Cilindrado**



**Porta Herramientas de Torno CSSP 45°
Exterior Aplicaciones Chaflanado**



**Porta Herramientas de Torno CSBP 75°
Exterior Aplicaciones Generales**



**Porta Herramientas de Torno CSTP 60°
Exterior Aplicaciones Generales**



**Porta Herramientas de Torno CSDP 45°
Exterior Aplicaciones Chaflanado**



**Porta Herramientas de Torno CTBP 75°
Exterior Aplicaciones Generales**



**Porta Herramientas de Torno CTCPN 90°
Exterior Aplicaciones Refrentado y
Ranurado**

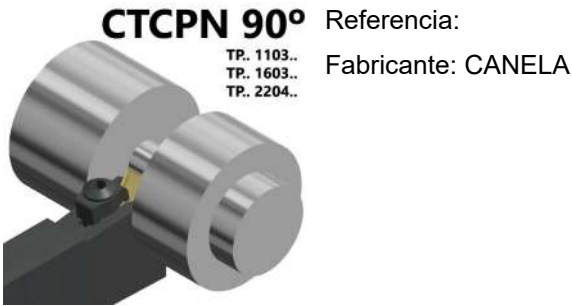

**Porta Herramientas de Torno CTCP 90°
Exterior Aplicaciones Refrentado y
Ranurado**

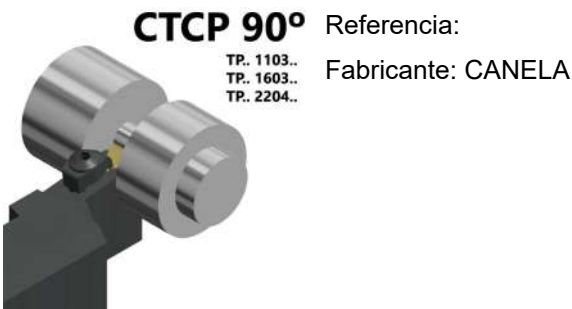

**Porta Herramientas de Torno CTDP 45°
Exterior Aplicaciones Chanflanado**

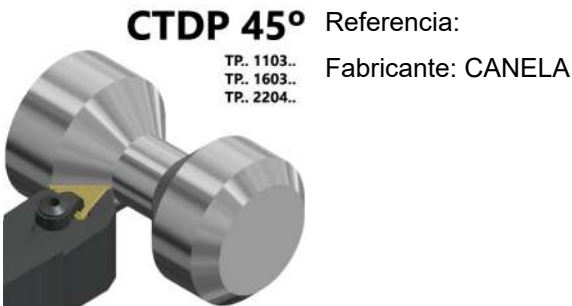

**Porta Herramientas de Torno CTFP 90°
Exterior Aplicaciones Refrentado**

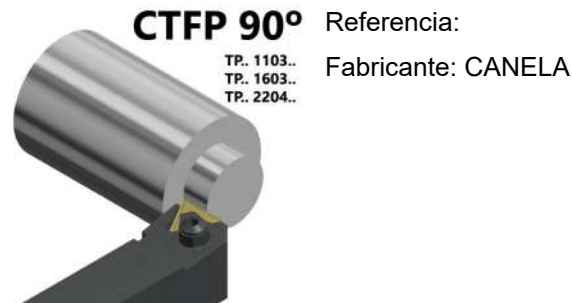

**Porta Herramientas de Torno CTPP 60°
Exterior Aplicaciones Chanflanado**

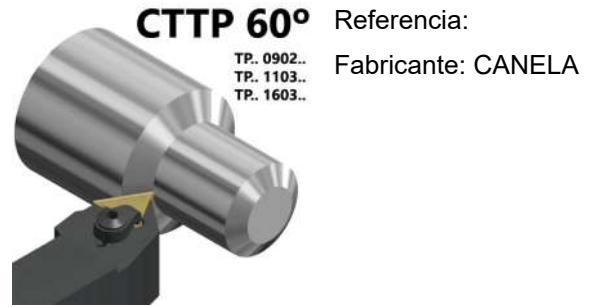

**Porta Herramientas de Torno CTGP 90°
Exterior Aplicaciones Generales**



**Porta Herramientas de Torno DCLN 95°
Exterior Aplicaciones Generales**



**Porta Herramientas de Torno DDJN 93°
Exterior Aplicaciones Generales**



**Porta Herramientas de Torno DSSN 45°
Exterior Aplicaciones Chanflanado**



DSSN 45°

SNM.. 1204..
SNM.. 1906..

Referencia:

Fabricante: CANELA

**Porta Herramientas de Torno MDJN-K 93°
Exterior Aplicaciones Generales**



MDJN-K 93°

DN.. 1506..

Referencia:

Fabricante: CANELA

**Porta Herramientas de Torno DWLN 95°
Exterior Aplicaciones Generales**



DWLN 95°

WNMG 0604..
WNMG 0804..

Referencia:

Fabricante: CANELA

**Porta Herramientas de Torno MSSN-K 45°
Exterior Aplicaciones Chanflanado**



MSSN-K 45°

SNM.. 1204..

Referencia:

Fabricante: CANELA

**Porta Herramientas de Torno MCLN 95°
Exterior Aplicaciones Generales**



MCLN 95°

CN.. 1204..
CN.. 1906..

Referencia:

Fabricante: CANELA

**Porta Herramientas de Torno MSSN 45°
Exterior Aplicaciones Chanflanado**



MSSN 45°

SNM.. 1204..
SNM.. 1906..

Referencia:

Fabricante: CANELA

**Porta Herramientas de Torno MCLN-K 95°
Exterior Aplicaciones Generales**



MCLN-K 95°

CN.. 1204..
CN.. 1906..

Referencia:

Fabricante: CANELA

**Porta Herramientas de Torno MTEN 60°
Exterior Aplicaciones Cilindrado**



MTEN 60°

TNM.. 1604..
TNM.. 2204..

Referencia:

Fabricante: CANELA

**Porta Herramientas de Torno MTJN 93°
Exterior Aplicaciones Copiado**

MTJN 93° Referencia:
TNM.. 1604..
TNM.. 2204..
Fabricante: CANELA



**Porta Herramientas de Torno MVQN-K 117°30'
Exterior Aplicaciones Generales**

MVQN-K 117°30' Referencia:
VN.. 1604..
Fabricante: CANELA

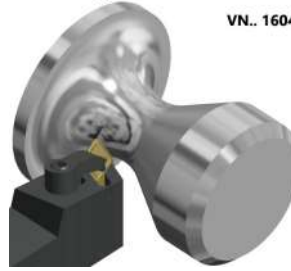

**Porta Herramientas de Torno MTJN-K 93°
Exterior Aplicaciones Copiado**

MTJN-K 93° Referencia:
TNM.. 1604..
TNM.. 2204..
Fabricante: CANELA



**Porta Herramientas de Torno MVVN-K 72°30'
Exterior Aplicaciones Copiado**

MVVN-K 72° 30' Referencia:
VN.. 1604..
Fabricante: CANELA



**Porta Herramientas de Torno MTNN 63°
Exterior Aplicaciones Cilindrado**

MTNN 63° Referencia:
TNM.. 1604..
TNM.. 2204..
Fabricante: CANELA



**Porta Herramientas de Torno MWLN 95°
Exterior Aplicaciones Generales**

MWLN 95° Referencia:
WNMG 0604..
WNMG 0804..
Fabricante: CANELA



**Porta Herramientas de Torno MVJN-K 93°
Exterior Aplicaciones Copiado**

MVJN-K 93° Referencia:
VN.. 1604..
Fabricante: CANELA

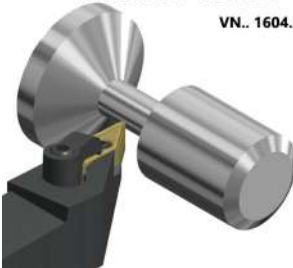

**Porta Herramientas de Torno MWLN-K 95°
Exterior Aplicaciones Generales**

MWLN-K 95° Referencia:
WNMG 0804..
Fabricante: CANELA



**Porta Herramientas de Torno PCBN 75°
Exterior Aplicaciones Cilindrado**



PCBN 75°

CN.. 1204..
CN.. 1606..
CN.. 1906..

Referencia:

Fabricante: CANELA

**Porta Herramientas de Torno PCMN 50°
Exterior Aplicaciones Cilindrado**



PCMN 50°

CN.. 1204..
CN.. 1906..

Referencia:

Fabricante: CANELA

**Porta Herramientas de Torno PCFN 90°
Exterior Aplicaciones de Refrentado**



PCFN 90°

CN.. 1204..
CN.. 1606..
CN.. 1906..

Referencia:

Fabricante: CANELA

**Porta Herramientas de Torno PCSN 45°
Exterior Aplicaciones Chaflanado**



PCSN 45°

CN.. 1204..
CN.. 1606..
CN.. 1906..

Referencia:

Fabricante: CANELA

**Porta Herramientas de Torno PCKN 75°
Exterior Aplicaciones de Refrentado**

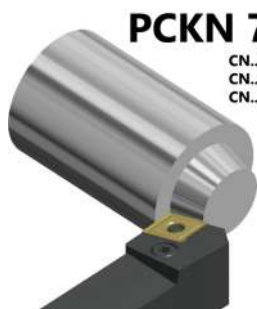

PCKN 75°

CN.. 1204..
CN.. 1606..
CN.. 1906..

Referencia:

Fabricante: CANELA

**Porta Herramientas de Torno PDJN 93°
Exterior Aplicaciones Copiado**



PDJN 93°

DN.. 1104..
DN.. 1506..

Referencia:

Fabricante: CANELA

**Porta Herramientas de Torno PCLN 95°
Exterior Aplicaciones Generales**

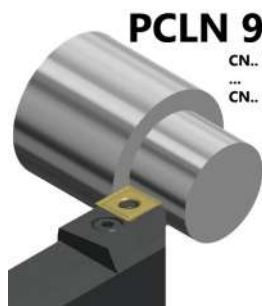

PCLN 95°

CN.. 0903..
...
CN.. 2509..

Referencia:

Fabricante: CANELA

**Porta Herramientas de Torno PDNN 63°
Exterior Aplicaciones Cilindrado**



PDNN 63°

DN.. 1506..

Referencia:

Fabricante: CANELA

**Porta Herramientas de Torno PRDC Exterior
Aplicaciones Cilindrado y Copiado**



PRDC

RC.. 1003M0
...
RC.. 3209M0

Referencia:

Fabricante: CANELA

**Porta Herramientas de Torno PSDN 45°
Exterior Aplicaciones Chaflanado**



PSDN 45°

SNM.. 0903..
...
SNM 2507..

Referencia:

Fabricante: CANELA

**Porta Herramientas de Torno PRSC Exterior
Aplicaciones Copiado**



PRSC

RC.. 10..32

Referencia:

Fabricante: CANELA

**Porta Herramientas de Torno PSKN 75°
Exterior Aplicaciones Chaflanado**



PSKN 75°

SNM.. 0903..
...
SNM 2507..

Referencia:

Fabricante: CANELA

**Porta Herramientas de Torno PRSN Exterior
Aplicaciones Cilindrado y Copiado**



PRSN

RNMG 09..25

Referencia:

Fabricante: CANELA

**Porta Herramientas de Torno PSSN 45°
Exterior Aplicaciones Chaflanado**



PSSN 45°

SNM.. 0903..
...
SNM.. 2507..

Referencia:

Fabricante: CANELA

**Porta Herramientas de Torno PSBN 75°
Exterior Aplicaciones Generales**



PSBN 75°

SNM.. 0903..
...
SNM.. 2507..

Referencia:

Fabricante: CANELA

**Porta Herramientas de Torno PTDN 45°
Exterior Aplicaciones de Chaflanado**



PTDN 45°

TNM.. 2204..

Referencia:

Fabricante: CANELA

**Porta Herramientas de Torno PTFN 90°
Exterior Aplicaciones de Refrentado**



PTFN 90°

TNM.. 1604..
TNM.. 2204..
TNM.. 2706..

Referencia:

Fabricante: CANELA

**Porta Herramientas de Torno SCAC 90°
Exterior Aplicaciones de Cilindrado**



SCAC 90°

CC.. 0602..
CC.. 09T3..
CC.. 1204..

Referencia:

Fabricante: CANELA

**Porta Herramientas de Torno PTGN 90°
Exterior Aplicaciones Generales**



PTGN 90°

TNM.. 1604..
...
TNM.. 3307..

Referencia:

Fabricante: CANELA

**Porta Herramientas de Torno SCLC 95°
Exterior Aplicaciones Generales**



SCLC 95°

CC.. 0602..
CC.. 09T3..
CC.. 1204..

Referencia:

Fabricante: CANELA

**Porta Herramientas de Torno PTTN 60°
Exterior Aplicaciones Chaflanado**



PTTN 60°

TNM.. 1604..
TNM.. 2204..

Referencia:

Fabricante: CANELA

**Porta Herramientas de Torno SDJC 93°
Exterior Aplicaciones Generales**



SDJC 93°

DC.. 0702..
DC.. 11T3..

Referencia:

Fabricante: CANELA

**Porta Herramientas de Torno PWLN 95°
Exterior Aplicaciones Generales**



PWLN 95°

WNM.. 0604..
WNM.. 0804..

Referencia:

Fabricante: CANELA

**Porta Herramientas de Torno SDNC 62°30'
Exterior Aplicaciones Copiado y Generales**



SDNC 62°30'

DC.. 0702..
DC.. 11T3..

Referencia:

Fabricante: CANELA

**Porta Herramientas de Torno SRDC Exterior
Aplicaciones Cilindrado**

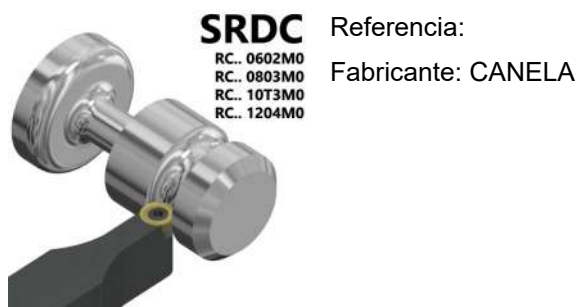

**Porta Herramientas de Torno STDC 45°
Exterior Aplicaciones Chaflanado**



**Porta Herramientas de Torno SSBC 75°
Exterior Aplicaciones Generales**



**Porta Herramientas de Torno STAC 90°
Exterior Aplicaciones Generales**

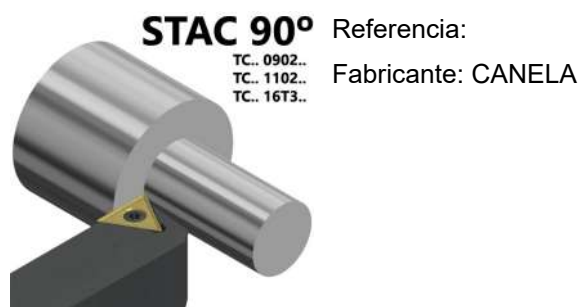

**Porta Herramientas de Torno SSDC 45°
Exterior Aplicaciones Chaflanado**



**Porta Herramientas de Torno STFC 90°
Exterior Aplicaciones Refrentado**



**Porta Herramientas de Torno SSSC 45°
Exterior Aplicaciones Chaflanado**



**Porta Herramientas de Torno STGC 90°
Exterior Aplicaciones Generales**



**Porta Herramientas de Torno STJC 93°
Exterior Aplicaciones Generales**



STJC 93°

TC.. 0902..
TC.. 1102..
TC.. 16T3..

Referencia:

Fabricante: CANELA

**Porta Herramientas de Torno SVJC 93°
Exterior Aplicaciones Cilindrado y Copiado**



SVJC 93°

VC.. 1103..
VC.. 1604..

Referencia:

Fabricante: CANELA

**Porta Herramientas de Torno STTC 60°
Exterior Aplicaciones Chaflanado**



STTC 60°

TC.. 0902..
TC.. 1102..
TC.. 16T3..

Referencia:

Fabricante: CANELA

**Porta Herramientas de Torno SVLC 95°
Exterior Aplicaciones Cilindrado y Copiado**



SVLC 95°

VC.. 1303..

Referencia:

Fabricante: CANELA

**Porta Herramientas de Torno SVHC 107°30'
Exterior Aplicaciones Cilindrado y Copiado**



SVHC 107°30'

VC.. 1604..

Referencia:

Fabricante: CANELA

**Porta Herramientas de Torno SVVB 72°30'
Exterior Aplicaciones Cilindrado y Copiado**



SVVB 72°30'

VBMT.. 1604..

Referencia:

Fabricante: CANELA

**Porta Herramientas de Torno SVJB 93°
Exterior Aplicaciones Cilindrado y Copiado**



SVJB 93°

VBMT 1604..

Referencia:

Fabricante: CANELA

**Porta Herramientas de Torno SVVC 72°30'
Exterior Aplicaciones Cilindrado y Copiado**



SVVC 72°30'

VC.. 1103..
VC.. 1604..

Referencia:

Fabricante: CANELA

**Porta Herramientas de Torno SVXC 113°
Exterior Aplicaciones Cilindrado y Copiado**



**Porta Herramientas de Torno DDJN 93°-A
Exterior Refrigerado Aplicaciones Generales**



**Porta Herramientas de Torno SVZC 100°
Exterior Aplica Exterior Aplicaciones
Cilindrado y Copiado**

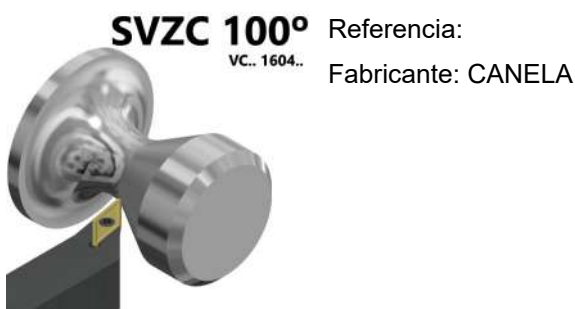

**Porta Herramientas de Torno DSSN 45°-A
Exterior Refrigerado Aplicaciones
Chanflanado**



**Porta Herramientas de Torno DTGN 90°
Exterior Aplicaciones Generales**



**Porta Herramientas de Torno DTJN 93°
Exterior Refrigerado Aplicaciones Generales**



**Porta Herramientas de Torno DCLN 95°-A
Exterior Refrigerado Aplicaciones Generales**



**Porta Herramientas de Torno DVJN 93°
Exterior Aplicaciones Generales**



**Porta Herramientas de Torno DVJN 93°
Exterior Refrigerado Aplicaciones Generales**



**Porta Herramientas de Torno SAGD 90°
Exterior torneando radios convexos**

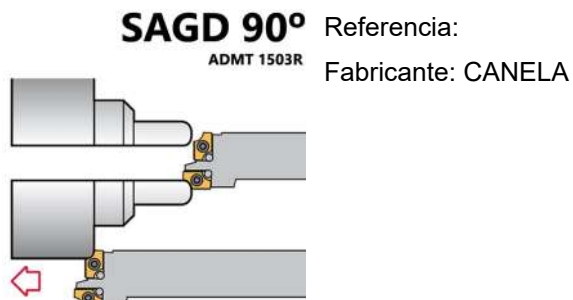

**Porta Herramientas de Torno DWLN 95°
Exterior Refrigerado Aplicaciones Generales**



**Porta Herramientas de Torno SCLC 95°-A
Exterior Refrigerado Aplicaciones Generales**



**STXCR para Torneado con grados variables
Interior y Exterior**

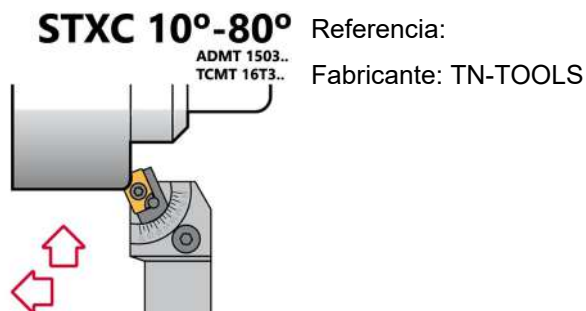

**Porta Herramientas de Torno SDAC 90°
Exterior Aplicaciones Generales**



**Porta Herramientas de Torno SVAC 90°
Exterior Aplicaciones Generales**

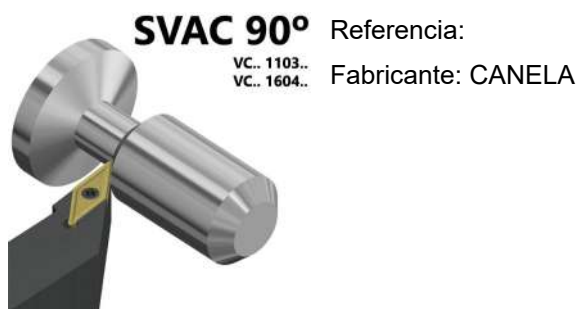

**Porta Herramientas de Torno SDHC 107,5°
Exterior Aplicaciones Generales**

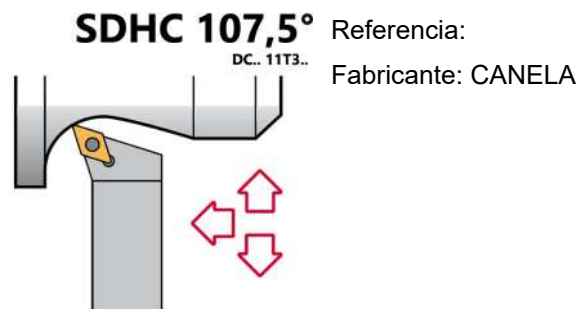

**Porta Herramientas de Torno SDJC 93°-A
Exterior Refrigerado Aplicaciones Generales**



SDJC 93°

DC.. 0702..
DC.. 11T3..

Referencia:

Fabricante: CANELA

**Porta Herramientas de Torno CKUN 93°
Interior de Cilindrado y Copiado**



CKUN 93°

KNUX 1604..

Referencia:

Fabricante: CANELA

**Porta Herramientas de Torno SCLC 95°-M
Exterior Aplicaciones Generales**



SCLC 95° -M

CC.. 0602..
CC.. 09T3..

Referencia:

Fabricante: CANELA

**Porta Herramientas de Torno CSKP 75°
Interior Aplicaciones Generales**



CSKP 75°

SP.. 0903..
SP.. 1203..
SP.. 1904..

Referencia:

Fabricante: CANELA

**Portaherramientas de centrado CNC SMOXH
CCT**



CNC PUNTA CENTERING TOOLS

Referencia:

Fabricante: SMOXH



**Porta Herramientas de Torno CTFP 90°
Interior Aplicaciones Generales**



CTFP 90°

TP.. 1103..
TP.. 1603..
TP.. 2204..

Referencia:

Fabricante: CANELA

**Porta Herramientas de Torno SRHCR/L
Exterior Aplicaciones Cilindrado y Copiado**



SRHCR/L

RC.1003..
RC.1204..
RC.1605..

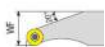

Referencia:

Fabricante: SMOXH



**Porta Herramientas de Torno CTUP 93°
Interior Aplicaciones Generales**



CTUP 93°

TP.. 0902..
TP.. 1103..
TP.. 1603..
TP.. 2204..

Referencia:

Fabricante: CANELA

**Porta Herramientas de Torno DCLN 95°
Interior de Aplicaciones Generales**

DCLN 95°

CN.. 1204..

Referencia:

Fabricante: CANELA



**Porta Herramientas de Torno MSKN-K 75°
Interior Aplicaciones Generales**

MSKN-K 75°

SNM.. 1204..

Referencia:

Fabricante: CANELA



**Porta Herramientas de Torno DDUN 93°
Interior Aplicaciones Cilindrado**

DDUN 93°

DN.. 1506..

Referencia:

Fabricante: CANELA



**Porta Herramientas de Torno MTFN 90°
Interior Aplicaciones Generales**

MTFN 90°

TNM.. 1604..

TNM.. 2204..

Referencia:

Fabricante: CANELA



**Porta Herramientas de Torno MCLN-K 95°
Interior Aplicaciones Generales**

MCLN-K 95°

CN.. 1204..

Referencia:

Fabricante: CANELA



**Porta Herramientas Torno MTFN-K 90°
Interior Aplicaciones Cilindrado**

MTFN-K 90°

TNM.. 1604..

Referencia:

Fabricante: CANELA



**Porta Herramientas de Torno MDUN-K 93°
Interior Aplicaciones Generales**

MDUN-K 93°

DN.. 1506..

Referencia:

Fabricante: CANELA



**Porta Herramientas de Torno MTUN 93°
Interior Aplicaciones Cilindrado**

MTUN 93°

TNM.. 1604..

TNM.. 2204..

Referencia:

Fabricante: CANELA



**Porta Herramientas Torno MVUN-K 93°
Interior Aplicaciones Cilindrado**

MVUN-K 93°
VN.. 1604..

Referencia:
Fabricante: CANELA



**Porta Herramientas de Torno PCLN 95°
Interior Aplicaciones Generales**

PLCN 95°
CN.. 1204..
CN.. 1606..

Referencia:
Fabricante: CANELA



**Porta Herramientas de Torno MWLN 95°
Interior Aplicaciones Generales**

MWLN 95°
WNM.. 0604..
WNM.. 0804..

Referencia:
Fabricante: CANELA



**Porta Herramientas de Torno PDUN 93°
Interior Aplicaciones Generales**

PDUN 93°
DN.. 1104..
DN.. 1506..

Referencia:
Fabricante: CANELA



**Porta Herramientas de Torno MWLN-K 95°
Interior Aplicaciones Generales**

MWLN-K 95°
WNM.. 0804..

Referencia:
Fabricante: CANELA



**Porta Herramientas de Torno PSKN 75°
Interior Aplicaciones Generales**

PSKN 75°
SNM.. 1204..
SNM.. 1906..

Referencia:
Fabricante: CANELA



**Porta Herramientas de Torno PCKN 75°
Interior Aplicaciones Generales**

PCKN 75°
CN.. 1204..
CN.. 1606..
CN.. 1906..

Referencia:
Fabricante: CANELA



**Porta Herramientas de Torno A-PSSN 45°
Interior Aplicaciones Generales**

A-PSSN 45°
SNM.. 1204..

Referencia:
Fabricante: CANELA



**Porta Herramientas de Torno PTFN 90°
Interior Aplicaciones Generales**



**Porta Herramientas de Torno A-SCLC 95°
Interior Aplicaciones Generales**



**Porta Herramientas de Torno PWLN 95°
Interior Aplicaciones Generales**



**Porta Herramientas de Torno H-SCLC 95°
Interior antivibrantes**



**Porta Herramientas de Torno A-PWLN 95°
Interior Aplicaciones Generales**



**Porta Herramienta Torno J-SCLC 95° Interior
antivibrante refrigeración**



**Porta Herramientas de Torno SCLC 95°
Interior Aplicaciones Generales**



**Porta Herramientas de Torno SCLCN 95°
Interior Aplicaciones Generales**



Porta Herramientas de Torno SDQC 107°30'
Interior Aplicaciones Generales

SDQC 107°30'

DC.. 0702..
DC.. 11T3..

Referencia:

Fabricante: CANELA



Porta Herramientas de Torno J-SDUC 93°
Interior Antivibrantes con Refrigeración

J-SDUC 93°

DC.. 0702..
DC.. 11T3..

Referencia:

Fabricante: CANELA

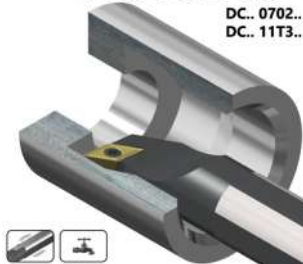

Porta Herramienta Torno A-SDQC 107°30'
Interior Aplicaciones Generales

A-SDQC 107°30'

DC.. 0702..
DC.. 11T3..

Referencia:

Fabricante: CANELA



Porta Herramientas de Torno H-SDUC 93°
Interior Antivibrantes

H-SDUC 93°

DC.. 0702..
DC.. 11T3..

Referencia:

Fabricante: CANELA

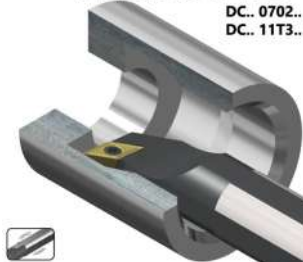

Porta Herramientas de Torno A-SDUC 93°
Interior Aplicaciones Generales

A-SDUC 93°

DC.. 0702..
DC.. 11T3..

Referencia:

Fabricante: CANELA



Porta Herramientas Torno SDUC 93°-EX
Interior Aplicaciones Generales

SDUC 93°-EX

DC.. 0702..
DC.. 11T3..

Referencia:

Fabricante: CANELA

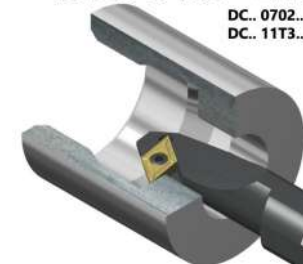

Porta Herramientas de Torno SDUC 93°
Interior Aplicaciones Generales

SDUC 93°

DC.. 0702..
DC.. 11T3..

Referencia:

Fabricante: CANELA



Porta Herramientas Torno A-SDUC 93°-EX
Interior Aplicaciones Generales

A-SDUC 93°-EX

DC.. 0702..
DC.. 11T3..

Referencia:

Fabricante: CANELA

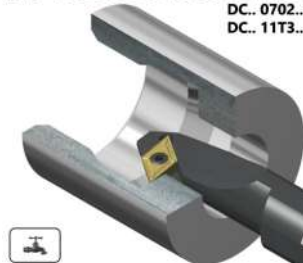

**Porta Herramientas Torno SSKC 75° Interior
Aplicaciones Generales**

SSKC 75°

SC.. 09T3..
SC.. 1204..

Referencia:

Fabricante: CANELA



**Porta Herramientas de Torno H-STFC 90°
Interior Antivibrantes**

H-STFC 90°

TC.. 0902..
TC.. 1102..
TC.. 16T3..

Referencia:

Fabricante: CANELA



**Porta Herramientas Torno A-SSSC 45°
Interior Aplicaciones Generales**

A-SSSC 45°

SC.. 09T3..

Referencia:

Fabricante: CANELA



**Porta Herramientas de Torno J-STFC 90°
Interior Antivibrantes con Refrigeración**

J-STFC 90°

TC.. 0902..
TC.. 1102..
TC.. 16T3..

Referencia:

Fabricante: CANELA



**Porta Herramientas Torno STFC 90° Interior
Aplicaciones Generales**

STFC 90°

TC.. 0902..
TC.. 1102..
TC.. 16T3..

Referencia:

Fabricante: CANELA



**Porta Herramientas Torno STUC 93° Interior
Aplicaciones Generales**

STUC 93°

TC.. 1102..
TC.. 16T3..

Referencia:

Fabricante: CANELA



**Porta Herramientas Torno A-STFC 90°
Interior Aplicaciones Generales**

A-STFC 90°

TC.. 0902..
TC.. 1102..
TC.. 16T3..

Referencia:

Fabricante: CANELA

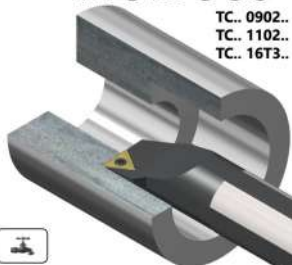

**Porta Herramientas Torno SVQC 107°30'
Interior Aplicaciones Generales**

SVQC 107° 30'

VC.. 1103..
VC.. 1303..
VC.. 1604..

Referencia:

Fabricante: CANELA

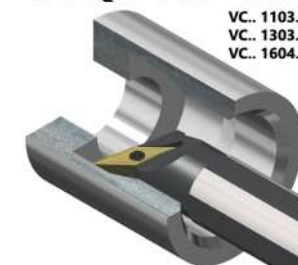

Porta Herramientas Torno A-SVQC 107°30'
Interior Aplicaciones Generales

A-SVQC 107° 30'

Referencia:

VC.. 1103..
VC.. 1303..
VC.. 1604..

Fabricante: CANELA

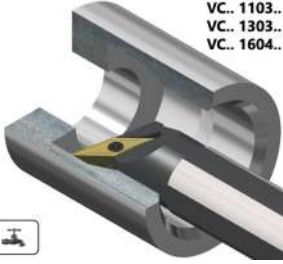

Porta Herramientas Torno A-SVJC 52°
Interior Aplicaciones Generales

A-SVJC 52°

Referencia:

VC.. 1103..
VC.. 1604..

Fabricante: CANELA

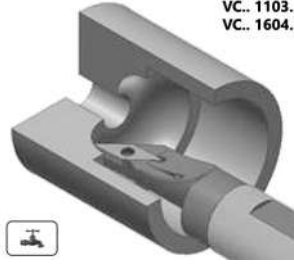

Porta Herramientas Torno SVUB 93° Interior
Aplicaciones Generales

SVUB 93°

VBMT 1604..

Referencia:

Fabricante: CANELA



Porta Herramientas Torno Cabezal Interior
PCLN 95° Aplicaciones Generales

PCLN 95°-N

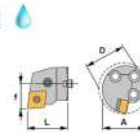

Referencia:

Fabricante: CANELA

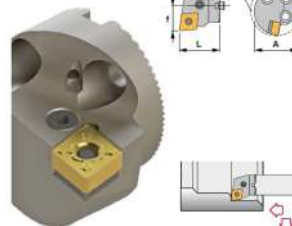

Porta Herramientas Torno SVUC 93° Interior
Aplicaciones Generales

SVUC 93°

VC.. 1103..
VC.. 1604..

Referencia:

Fabricante: CANELA



Porta Herramientas Torno Cabezal Interior
PDUN 93° Aplicaciones Generales

PDUN 93°-N

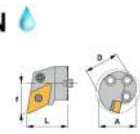

Referencia:

Fabricante: CANELA

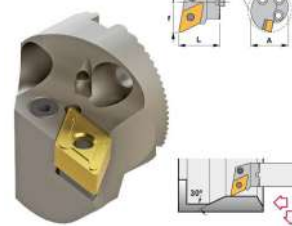

Porta Herramientas Torno A-SVUC 93°
Interior Aplicaciones Generales

A-SVUC 93°

VC.. 1103..
VC.. 1604..

Referencia:

Fabricante: CANELA



Mango Antivibrante Con Refrigeración
Interna



Referencia:

Fabricante: CANELA

Barras antivibratorias
Anti-vibration tools

**Porta Herramientas Torno Cabezal Interior
MTUN 93° Aplicaciones Generales**

MTUN 93°-N 

Referencia:
Fabricante: CANELA

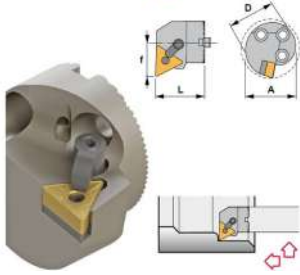

**Porta Herramientas Torno Cabezal Interior
STFC 90° Aplicaciones Generales**

STFC 90°
TC.. 16T3..

Referencia:
Fabricante: CANELA



**Porta Herramientas Torno Cabezal Interior
SCLC 95° Aplicaciones Generales**

SCLC 95°
CC.. 09T3..
CC.. 1204..

Referencia:
Fabricante: CANELA



**Porta Herramientas de Torno PDUN 93° -EX
Interior Aplicaciones Generales**

PDUN 93°-EX
DN.. 1506..

Referencia:
Fabricante: CANELA



**Porta Herramientas Torno Cabezal Interior
PWLN 95° Aplicaciones Generales**

PWLN 95°
WNM.. 0804..

Referencia:
Fabricante: CANELA

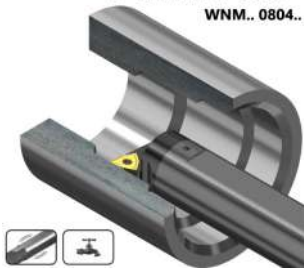

**Porta Herramientas Torno Cabezal Interior
SDUC 93° Aplicaciones Generales**

SDUC 93°
DC.. 11T3..

Referencia:
Fabricante: CANELA



También disponemos de las siguientes marcas:



Entre muchas otras...

Portaherramientas y Placas de Ranurado/Tronzado

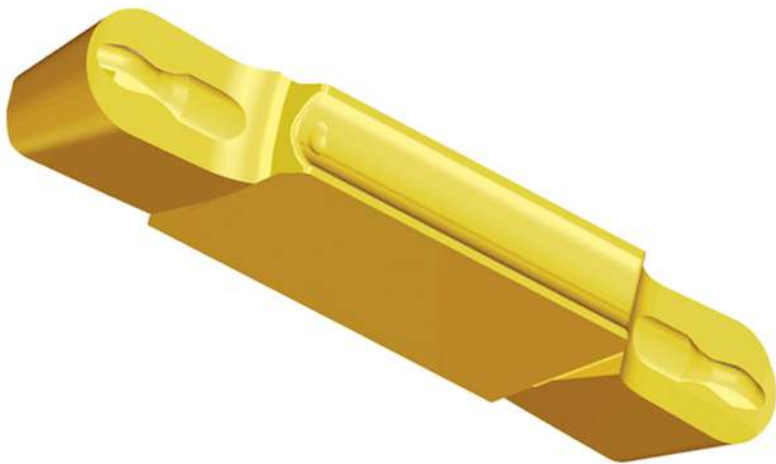
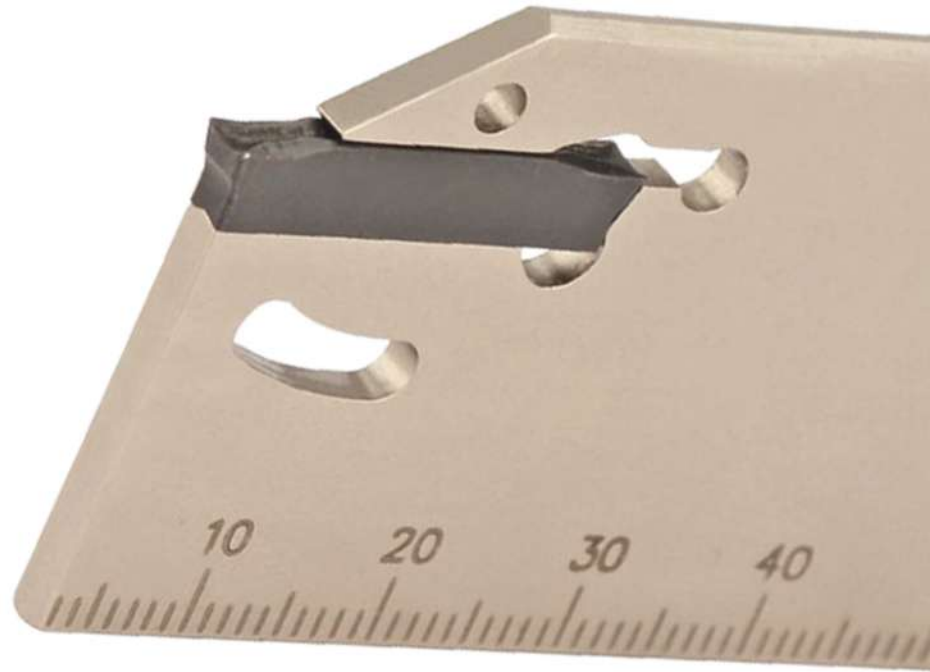

GY2M0300F030N-GM VP20RT Placa de Ranurado

* Corte Inestable
Unstable Cutting



Referencia: PRNM01

Fabricante: TN-TOOLS



Taegutec TDXU de Ranurado y Tronzado

● Primera opción
First Option
○ Segunda Opción
Second Option



Referencia:

Fabricante: TT



Taegutec TSC TT8020 Placa de Ranurado

● Primera opción
First Option
○ Segunda Opción
Second Option



Referencia: PRNT01

Fabricante: TT



Canela-XLCF- Portaherramientas para tronzado y ranurado

XLCF
TGV
PTNT

Referencia:

Fabricante: CANELA

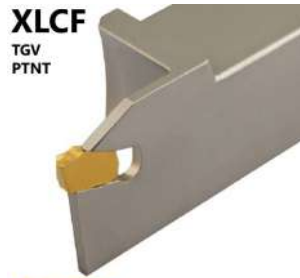

CANELA

Portaherramientas de ranurado Smoxh para plaquita GY2M

BDKT/R 2525 GYM2M

Referencia:

Fabricante: SMOXH



SMOXH
CUTTING TOOLS

Canela PTNT.. Placa de Ranurado y Tronzado

PTNT..

MATERIALES	PTNT05	PTNT06	PTNT07	PTNT08	PTNT09	PTNT10	PTNT11	PTNT12	PTNT13	PTNT14	PTNT15	PTNT16	PTNT17	PTNT18	PTNT19	PTNT20
P	SC	SC	SC	SC	SC	SC	SC	SC	SC	SC	SC	SC	SC	SC	SC	SC
M	SC	SC	SC	SC	SC	SC	SC	SC	SC	SC	SC	SC	SC	SC	SC	SC
K	SC	SC	SC	SC	SC	SC	SC	SC	SC	SC	SC	SC	SC	SC	SC	SC
N	SC	SC	SC	SC	SC	SC	SC	SC	SC	SC	SC	SC	SC	SC	SC	SC
S	SC	SC	SC	SC	SC	SC	SC	SC	SC	SC	SC	SC	SC	SC	SC	SC
H	SC	SC	SC	SC	SC	SC	SC	SC	SC	SC	SC	SC	SC	SC	SC	SC

Referencia:

Fabricante: CANELA

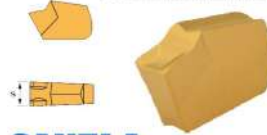

CANELA

Taegutec Lama TGB para placa ranurado y tronzado

TGB

Referencia:

Fabricante: TT



Canela-CPTS-Portalamas de tronzado y ranurado

CPTS..

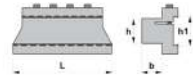

Referencia:

Fabricante: CANELA



CANELA

También disponemos de las siguientes marcas:



Entre muchas otras...

Sets de Torneado



Set A SCLC 95°..06 Portaherramientas Interiores de Torno



Referencia:
Fabricante: TN-TOOLS

Set SDUC 93° Portaherramientas de Torneado Interior



Referencia:
Fabricante: TN-TOOLS

Set TN-STXCR para Torneado con Grados Variables Interior y Exterior



Referencia:
Fabricante: TN-TOOLS

Set SDQC 107°30' Portaherramientas Interiores de Torno



Referencia:
Fabricante: TN-TOOLS

Set STFC 90° Portaherramientas Interiores de Torno



Referencia:
Fabricante: TN-TOOLS

Portaherramientas Soldadas

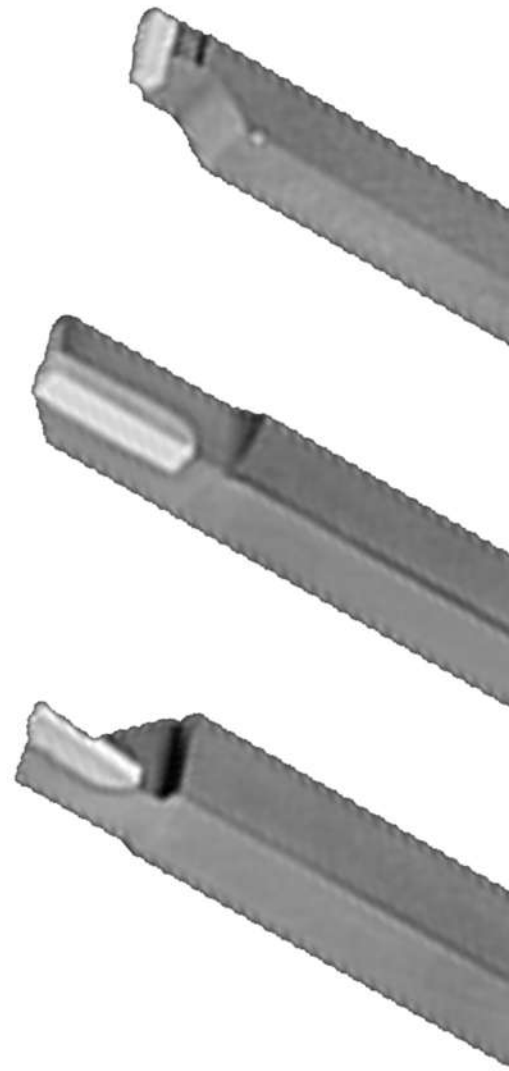

Portaherramientas Soldadas Coventry ISO 1 de Torneado Exterior



Referencia:
Fabricante: COVENTRY



COVENTRY

Portaherramientas Soldadas de Widia ISO 2 45° para Torneado Exterior



Referencia:
Fabricante: CANELA



ISO 2 45°

Portaherramientas Soldadas de Widia ISO 1 20° para Torneado Exterior Blue-Master



Referencia:
Fabricante: BLUE-MASTER



BLUE-MASTER

Portaherramientas Soldadas de Widia ISO 3 5° para Torneado Exterior Blue-Master



Referencia:
Fabricante: BLUE-MASTER



BLUE-MASTER

Portaherramientas Soldadas Coventry ISO 2 45° de Torneado Exterior



Referencia:
Fabricante: COVENTRY



COVENTRY

Portaherramientas Soldadas de Widia ISO 4 para Torneado Exterior Blue-Master



Referencia:
Fabricante: BLUE-MASTER



BLUE-MASTER

Portaherramientas Soldadas de Widia ISO 2 45° para Torneado Exterior Blue-Master



Referencia:
Fabricante: BLUE-MASTER



BLUE-MASTER

Portaherramientas Soldadas de Widia ISO 5 5° para Torneado Exterior Blue-Master



Referencia:
Fabricante: BLUE-MASTER



BLUE-MASTER

Portaherramientas Soldadas Coventry ISO 6 90° para Torneado y Refrentar



Referencia:
Fabricante: COVENTRY



COVENTRY

Portaherramientas Soldadas de Widia ISO 7 90° para Torneado Exterior Blue-Master



Referencia:
Fabricante: BLUE-MASTER



BLUE-MASTER

Portaherramientas Soldadas de Widia ISO 6 90° para Torneado Exterior Blue-Master



Referencia:
Fabricante: BLUE-MASTER



BLUE-MASTER

Portaherramientas Soldadas de Widia ISO 7 90° para Torneado Exterior



Referencia:
Fabricante: CANELA



ISO 7 90°

Portaherramientas Soldadas de Widia ISO 6 90° para Torneado Exterior



Referencia:
Fabricante: CANELA



ISO 6 90°

Portaherramientas Soldadas Coventry ISO 8 de Torneado Interior Desbaste



Referencia:
Fabricante: COVENTRY



COVENTRY

Portaherramientas Soldadas Coventry ISO 7 de Ranurado y Tronzado



Referencia:
Fabricante: COVENTRY



COVENTRY

Portaherramientas Soldadas de Widia ISO 8 para Torneado Interior Blue-Master



Referencia:
Fabricante: CANELA



BLUE-MASTER

Portaherramientas Soldadas Coventry ISO 9 de Torneado Interior Acabado



Referencia:
Fabricante: COVENTRY



COVENTRY

Portaherramientas Soldadas de Widia ISO 10 180° para Torneado Exterior Blue-Master



Referencia:
Fabricante: BLUE-MASTER



BLUE-MASTER

Portaherramientas Soldadas de Widia ISO 9 90° para Torneado Interior Blue-Master



Referencia:
Fabricante: BLUE-MASTER



BLUE-MASTER

Portaherramientas Soldadas Coventry ISO 11 para Ranurado Interior



Referencia:
Fabricante: COVENTRY



COVENTRY

Portaherramientas Soldadas de Widia ISO 9 90° para Torneado Interior



Referencia:
Fabricante: CANELA



ISO 9 90°

Portaherramientas Soldadas de Widia ISO 11 para Ranurado Interior



Referencia:
Fabricante: CANELA



BLUE-MASTER

Portaherramientas Soldadas Coventry ISO 10 de Torno para Acabados



Referencia:
Fabricante: COVENTRY



COVENTRY

Portaherramientas Soldadas de Widia ISO 12 para Roscado Exterior Blue-Master



Referencia:
Fabricante: BLUE-MASTER



BLUE-MASTER

Portaherramientas Soldadas de Widia ISO 13 para Roscado Interior Blue-Master



Referencia:
Fabricante: BLUE-MASTER



BLUE-MASTER®

Portaherramientas Soldadas de Widia ISO 351 80° para Torneado Exterior



Referencia:
Fabricante: CANELA



ISO 351 80°

Portaherramientas Soldadas de Widia UI 30 60° para Roscado Exterior



Referencia:
Fabricante: CANELA



UI 30 60°

Portaherramientas Soldadas Coventry ISO 352 60° para Roscado Exterior



Referencia:
Fabricante: COVENTRY



COVENTRY®

Portaherramientas Soldadas de Widia UI 40 60° para Roscado Interior



Referencia:
Fabricante: CANELA



UI 40 60°

Portaherramientas Soldadas Coventry ISO 353 60° para Roscado Interior



Referencia:
Fabricante: COVENTRY



COVENTRY®

Portaherramientas Soldadas de Widia UI 50 90° para Ranurado Interior



Referencia:
Fabricante: CANELA



UI 50 60°

Cuchillas de Cobalto



Cuchilla Cuadrada de Cobalto Coventry



Referencia:
Fabricante: COVENTRY



COVENTRY

Cuchillas Cuadradas de Cobalto 10% Para Torno DIN4964 Forma B



Referencia:
Fabricante: BLUE-MASTER



BLUE-MASTER

Cuchilla Redonda de Cobalto Coventry



Referencia:
Fabricante: COVENTRY



COVENTRY

Cuchillas Redondas de Cobalto 10% Para Torno DIN4964 Forma A



Referencia:
Fabricante: CANELA



BLUE-MASTER

Cuchilla Rectangular de Cobalto Coventry



Referencia:
Fabricante: COVENTRY



COVENTRY

Cuchillas Rectangulares de Cobalto 10% Para Torno DIN4964 Forma D



Referencia:
Fabricante: BLUE-MASTER



BLUE-MASTER

Cuchilla Trapezoidal de Cobalto Coventry



Referencia:
Fabricante: COVENTRY

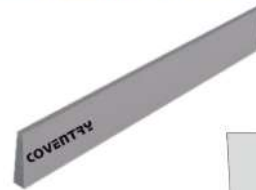

COVENTRY

Cuchilla Trapezoidal L-1 de Cobalto Coventry



Referencia:
Fabricante: COVENTRY



COVENTRY

Cuchilla Trapezoidal L-2 de Cobalto Coventry



Referencia:
Fabricante: COVENTRY



COVENTRY

Cuchillas Trapeciales de Cobalto 10% Para Torno DIN4964 Forma E

Co

HSSCo
10%

DIN
4964

FORMA
E

TOL
h12

Referencia:

Fabricante: BLUE-MASTER



BLUE-MASTER®



Cuchillas Trapeciales de Cobalto 10% Para Torno DIN4964 Forma Index 1

Co

HSSCo
10%

DIN
4964

FORMA
INDEX1

TOL
h12

Referencia:

Fabricante: BLUE-MASTER



BLUE-MASTER®



Torretas, Platos y Garras

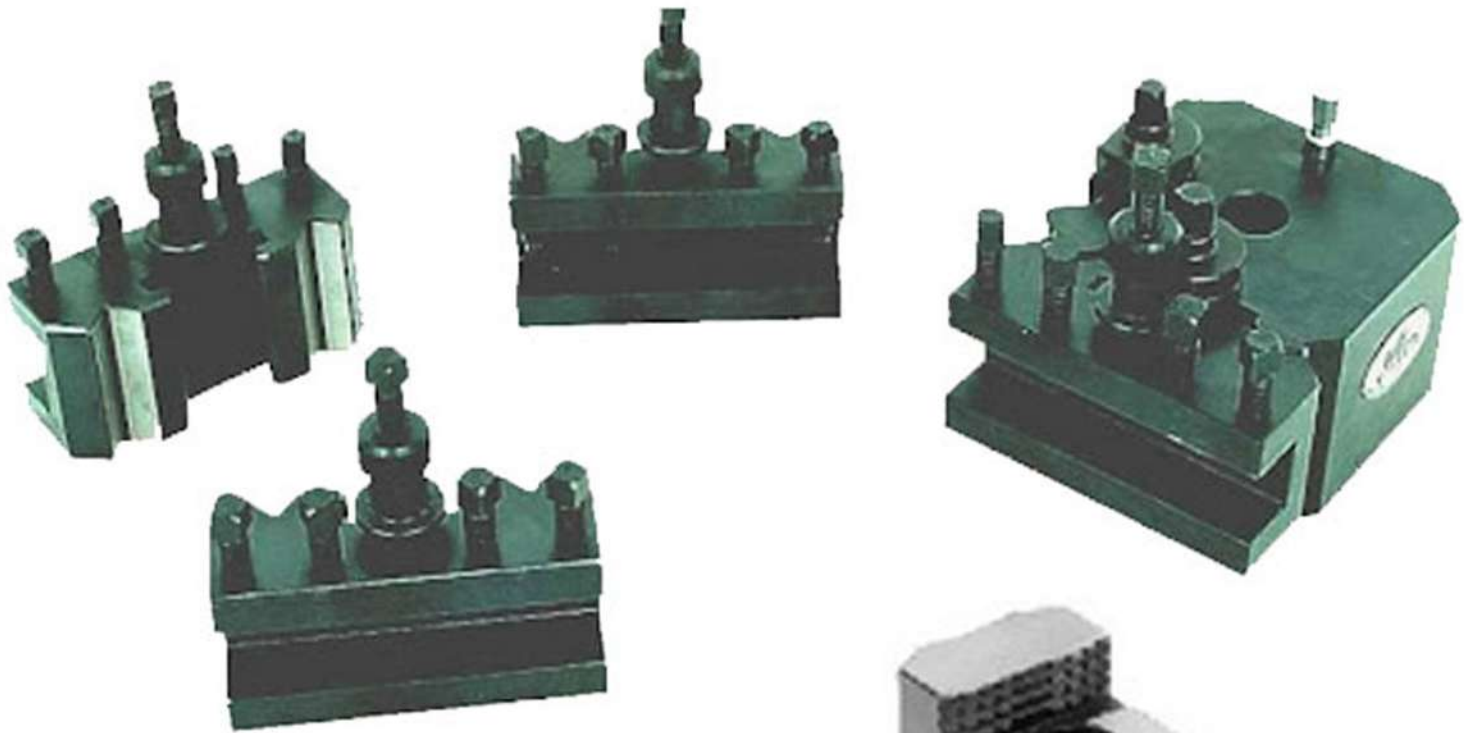

Torreta Portaherramientas Suelta 2 Caras Lardi-Mecanizados Huesca



Referencia:
Fabricante: Mecanizados



2 CARAS

COMPATIBLE CON LARDI

Portador apoyo en V Lardi-Mecanizados Huesca



Referencia:
Fabricante: Mecanizados

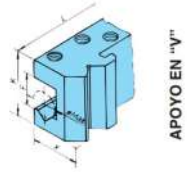

APOYO EN "V"

Torreta Portaherramientas Suelta 3 Caras Lardi-Mecanizados Huesca



Referencia:
Fabricante: Mecanizados



3 CARAS

COMPATIBLE CON LARDI

Portador de barras Lardi-Mecanizados Huesca



Referencia:
Fabricante: Mecanizados

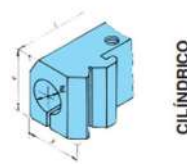

CILÍNDRICO

KIT DE TORRETA 2 y 3 caras + 4 PORTAHERRAMIENTAS Lardi-Mecanizados Huesca



Referencia:
Fabricante: Mecanizados



COMPATIBLE CON LARDI

Portador de cono morse Lardi-Mecanizados Huesca



Referencia:
Fabricante: Mecanizados

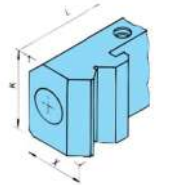

CONO MORSE

Portador de apoyo plano Lardi-Mecanizados Huesca



Referencia:
Fabricante: Mecanizados

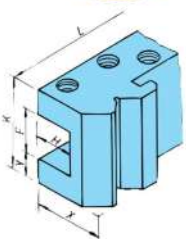

APOYO PLANO

Recambios Torretas Lardi-Mecanizados Huesca

MECANIZADOS HUESCA / LARDI

Referencia:
Fabricante:

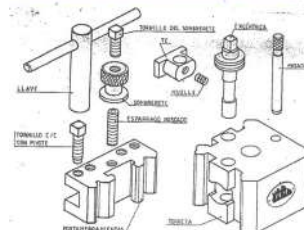

Platos Universales TOS de 3 garras de fundicion



Referencia:
Fabricante: TOS

Platos de Precision TOS de 4 garras de Fundicion DIN 6350 IUG (FIJACION DELANTERA y TRASERA)



Referencia:
Fabricante: TOS

Platos de Precision TOS de 3 garras de Fundicion DIN 6350 IUG (FIJACION DELANTERA y TRASERA)



Referencia:
Fabricante: TOS

Platos Universales TOS de 4 garras de ACERO DIN 6350



Referencia:
Fabricante: TOS

Platos Universales TOS de 3 garras de ACERO DIN 6350



Referencia:
Fabricante: TOS

Platos TOS de 4 garras independientes



Referencia:
Fabricante: TOS

Platos Universales TOS de 4 garras de fundicion



Referencia:
Fabricante: TOS

Garras Blandas adaptables a los Platos Hidraulicos para FORKARDT

ADP. FORKARDT

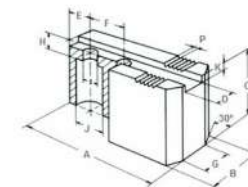

Referencia:
Fabricante: GAMOR

Garras Blandas adaptables a los Platos Hidraulicos para Galvez-Hidram

ADP.Galvez-Hidram

Referencia:
Fabricante: GAMOR

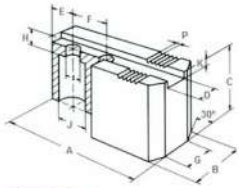

Garras Blandas adaptables a los Platos Hidraulicos para KITAGAWA

ADP. KITAGAWA

Referencia:
Fabricante: GAMOR

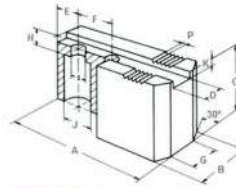

Garras Blandas adaptables a los Platos Hidraulicos para GAMET

ADP. GAMET

Referencia:
Fabricante: GAMOR

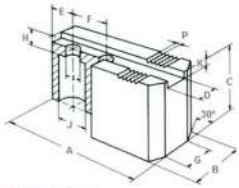

Garras Blandas adaptables a los Platos Hidraulicos para LAN-GAI

ADP. LAN-GAI

Referencia:
Fabricante: GAMOR

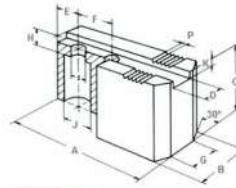

Garras Blandas adaptables a los Platos Hidraulicos para GAMET GA

ADP. GAMET GA

Referencia:
Fabricante: GAMOR

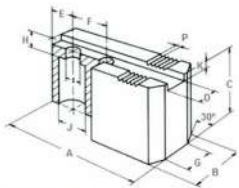

Garras Blandas adaptables a los Platos Hidraulicos para MAN

ADP. MAN

Referencia:
Fabricante: GAMOR

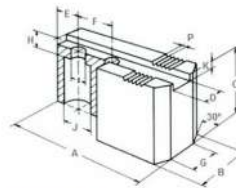

Garras Blandas adaptables a los Platos Hidraulicos para HOWA

ADP. HOWA

Referencia:
Fabricante: GAMOR

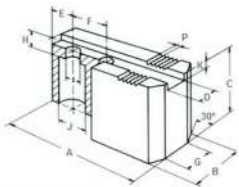

Garras Blandas adaptables a los Platos Hidraulicos para MMK (Torno Leadwell)

ADP. MMK

Referencia:
Fabricante: GAMOR

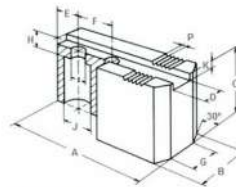

Garras Blandas adaptables a los Platos Hidraulicos para ROHM

ADP. ROHM

Referencia:
Fabricante: GAMOR

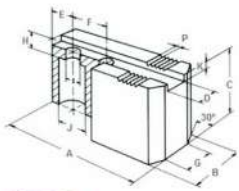

Garras Blandas adaptables a los Platos Universales para ECIA

ECIA

Referencia:
Fabricante: GAMOR

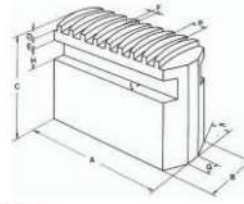

Garras Blandas adaptables a los Platos Hidraulicos para SMW - AUTOBLOK

ADP. SMW-AUTOBLOK

Referencia:
Fabricante: GAMOR

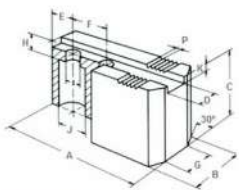

Garras Blandas adaptables a los Platos Universales para MAN

MAN

Referencia:
Fabricante: GAMOR

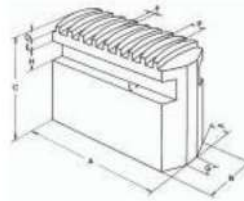

Garras Blandas adaptables a los Platos Universales para Bison + Gamor + MK-LG

BISON-GAMOR-MK-LG

Referencia:
Fabricante: GAMOR

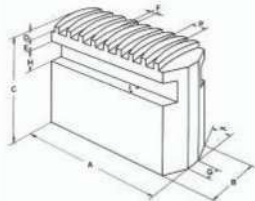

Garras Blandas adaptables a los Platos Universales para MARCA P.C

P-C

Referencia:
Fabricante: GAMOR

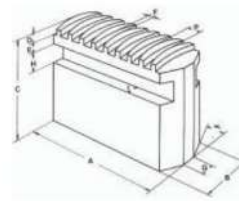

Garras Blandas adaptables a los Platos Universales para BURNERD

BURNERD

Referencia:
Fabricante: GAMOR

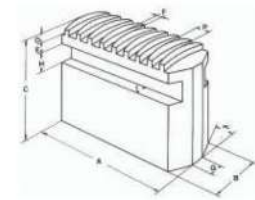

Garras Blandas adaptables a los Platos Universales para MEEHANITE CHIANDAO

MEEHANITE CHIANDAO

Referencia:
Fabricante: GAMOR

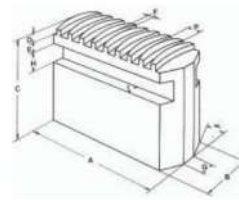

Garras Blandas adaptables a los Platos Universales para MK-G

MK-G

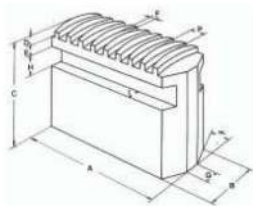

GAMOR

Referencia:
Fabricante: GAMOR

Garras Blandas adaptables a los Platos Universales para TDG.MA

TDG-MA

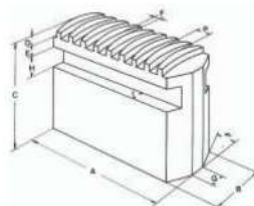

GAMOR

Referencia:
Fabricante: GAMOR

Garras Blandas adaptables a los Platos Universales para MK-N

MK-N

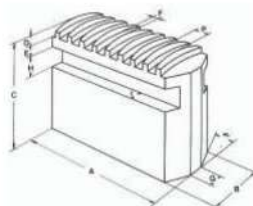

GAMOR

Referencia:
Fabricante: GAMOR

Garras Blandas adaptables a los Platos Universales para TDG.MN

TDG-MN

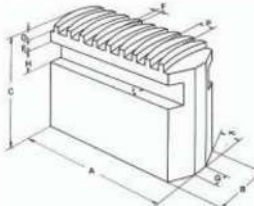

GAMOR

Referencia:
Fabricante: GAMOR

Garras Blandas adaptables a los Platos Universales para PLATO RUSO

PLATO RUSO

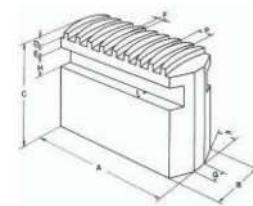

GAMOR

Referencia:
Fabricante: GAMOR

Garras Blandas adaptables a los Platos Universales para TARRACO

TARRACO

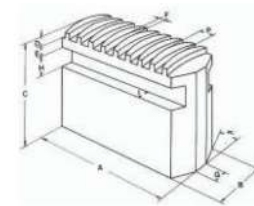

GAMOR

Referencia:
Fabricante: GAMOR

Garras Blandas adaptables a los Platos Universales para ROHM

ROHM

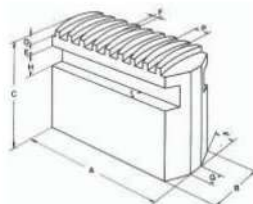

GAMOR

Referencia:
Fabricante: GAMOR

Garras Blandas adaptables a los Platos Universales para TOS-TDG21

TOS-TDG21

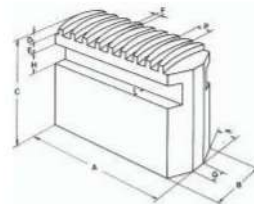

GAMOR

Referencia:
Fabricante: GAMOR

Garras Blandas Postizas adaptables para BISON-GAMOR UNIVERSALES

BISON-GAMOR UNIVERSALES

Referencia:

Fabricante: GAMOR

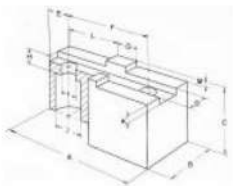

GAMOR

Garras Blandas Postizas adaptables para PLATO ROHM

ROHM

Referencia:

Fabricante: GAMOR

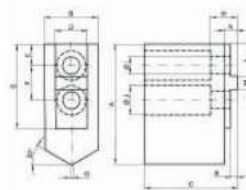

GAMOR

Garras Blandas Postizas adaptables para BISON INDEPENDIENTES

BISON INDEPENDIENTES

Referencia:

Fabricante: GAMOR

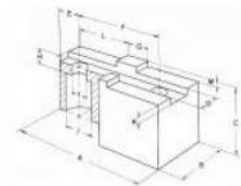

GAMOR

Garras Duras adaptables a los platos hidraulicos AUTOBLOK — SMW

AUTOBLOK-SMW MOD.L

Referencia:

Fabricante: GAMOR

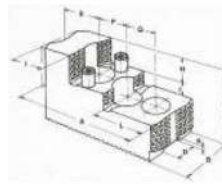

GAMOR

Garras Blandas Postizas adaptables para ROHM-AUTOBLOK

ROHM-AUTOBLOK

Referencia:

Fabricante: GAMOR

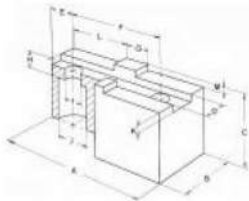

GAMOR

Garras Duras adaptables a los platos hidraulicos AUTOBLOK — SMW MOD. N

AUTOBLOK-SMW MOD.N

Referencia:

Fabricante: GAMOR

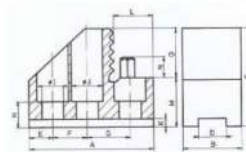

GAMOR

Garras Blandas Postizas adaptables para PLATO GALVEZ — HIDRAM

GALVEZ-HIDRAM

Referencia:

Fabricante: GAMOR

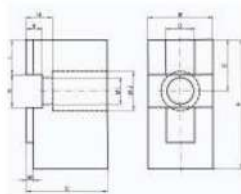

GAMOR

Garras Duras adaptables a los platos hidraulicos AUTOBLOK SMW MOD. GD

AUTOBLOK-SMW MOD.GD

Referencia:

Fabricante: GAMOR

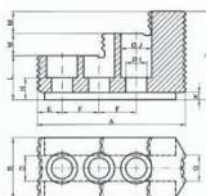

GAMOR

**Garras Duras adaptables a los platos
hidraulicos GALVEZ - HIDRAM MOD. GD**

GALVEZ-HIDRAM MOD.GD

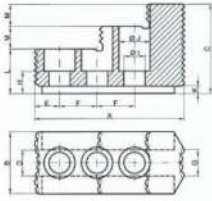

Referencia:
Fabricante: GAMOR

**Garras Duras adaptables a los platos
hidraulicos GAMET GA MOD.L**

GAMET GA MOD.L

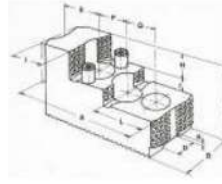

Referencia:
Fabricante: GAMOR

**Garras Duras adaptables a los platos
hidraulicos GALVEZ - HIDRAM MOD.L**

GALVEZ-HIDRAM MOD.L

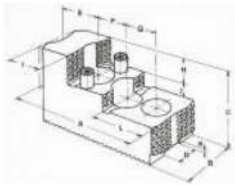

Referencia:
Fabricante: GAMOR

**Garras Duras adaptables a los platos
hidraulicos GAMET GA MOD. N**

GAMET GA MOD.N

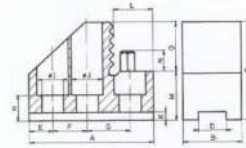

Referencia:
Fabricante: GAMOR

**Garras Duras adaptables a los platos
hidraulicos GALVEZ - HIDRAM MOD.N**

GALVEZ-HIDRAM MOD.N

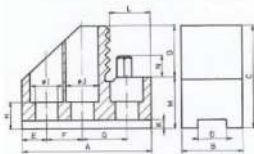

Referencia:
Fabricante: GAMOR

**Garras Duras adaptables a los platos
hidraulicos HOWA MOD. GD**

HOWA MOD.GD

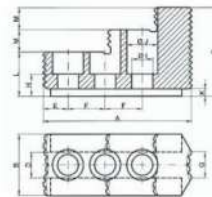

Referencia:
Fabricante: GAMOR

**Garras Duras adaptables a los platos
hidraulicos GAMET GA MOD. GD**

GALVEZ-HIDRAM MOD.GD

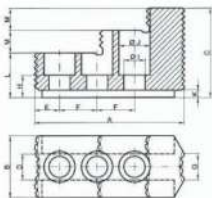

Referencia:
Fabricante: GAMOR

**Garras Duras adaptables a los platos
hidraulicos HOWA MOD.L**

HOWA MOD.L

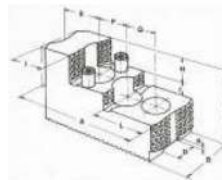

Referencia:
Fabricante: GAMOR

Garras Duras adaptables a los platos hidraulicos HOWA MOD. N

HOWA MOD.N

Referencia:

Fabricante: GAMOR

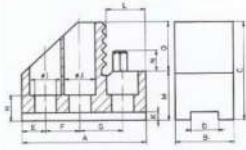

Garras Duras adaptables a los platos hidraulicos KITAGAWA MOD. GD

HOWA MOD.GD

Referencia:

Fabricante: GAMOR

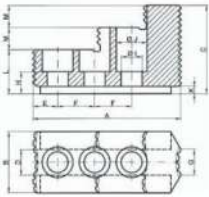

Garras Duras adaptables a los platos hidraulicos KITAGAWA MOD.L

KITAGAWA MOD.L

Referencia:

Fabricante: GAMOR

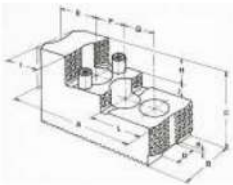

Garras Duras adaptables a los platos hidraulicos KITAGAWA MOD.N

KITAGAWA MOD.N

Referencia:

Fabricante: GAMOR

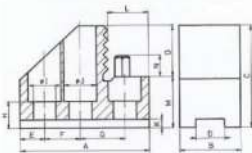

Tes de amarre adaptables a platos neumáticos e hidráulicos N° 24 / N° 25 (precio por unidad)

TES DE AMARRE ADAPTABLES N° 24

Referencia:

Fabricante: GAMOR

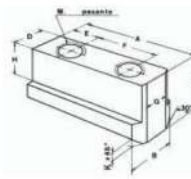

Tes de amarre adaptables a platos neumáticos e hidráulicos N° 24 - E / N° 24 - E2 (precio por unidad)

TES DE AMARRE ADAPTABLES N° 24-E

Referencia:

Fabricante: GAMOR

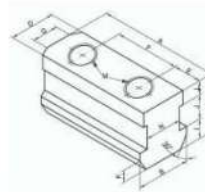

Tes de amarre adaptables a platos neumáticos e hidráulicos N° 26 - 27 (precio por unidad)

TES DE AMARRE ADAPTABLES N° 26

Referencia:

Fabricante: GAMOR

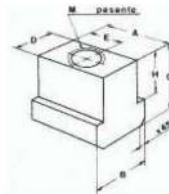

Tes de amarre adaptables a platos neumáticos e hidráulicos N° 26 - E / N° 30 (precio por unidad)

TES DE AMARRE ADAPTABLES N° 26-E

Referencia:

Fabricante: GAMOR

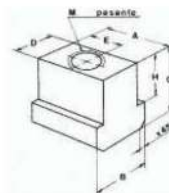

Tes de amarre adaptables a platos neumáticos e hidráulicos N° 28 / N° 29 (precio por unidad)

TES DE AMARRE ADAPTABLES N° 28

Referencia:
Fabricante: GAMOR

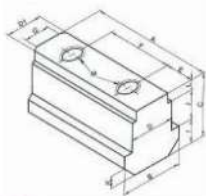

GAMOR

Garras Duras adaptables a los Platos Universales para TOS - TDG 21

TOS-TDG21

Referencia:
Fabricante: GAMOR

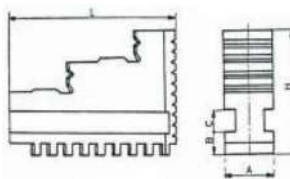

GAMOR

Garras Duras adaptables a los Platos Universales para BISON + GAMOR +MK - LG

BISON-GAMOR-MK-LG

Referencia:
Fabricante: GAMOR

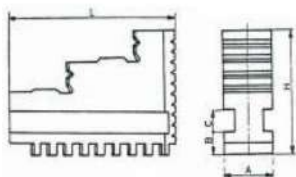

GAMOR

Garras Duras adaptables a los Platos Universales para MK - G

MK-G

Referencia:
Fabricante: GAMOR

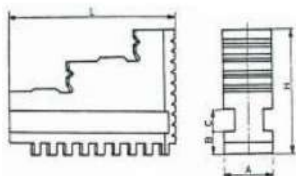

GAMOR

Garras Duras adaptables a los Platos Universales para MK - N

MK-N

Referencia:
Fabricante: GAMOR

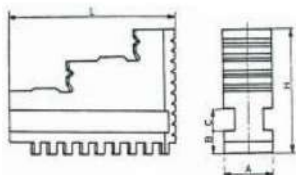

GAMOR